

King Sturge 4/7/2006

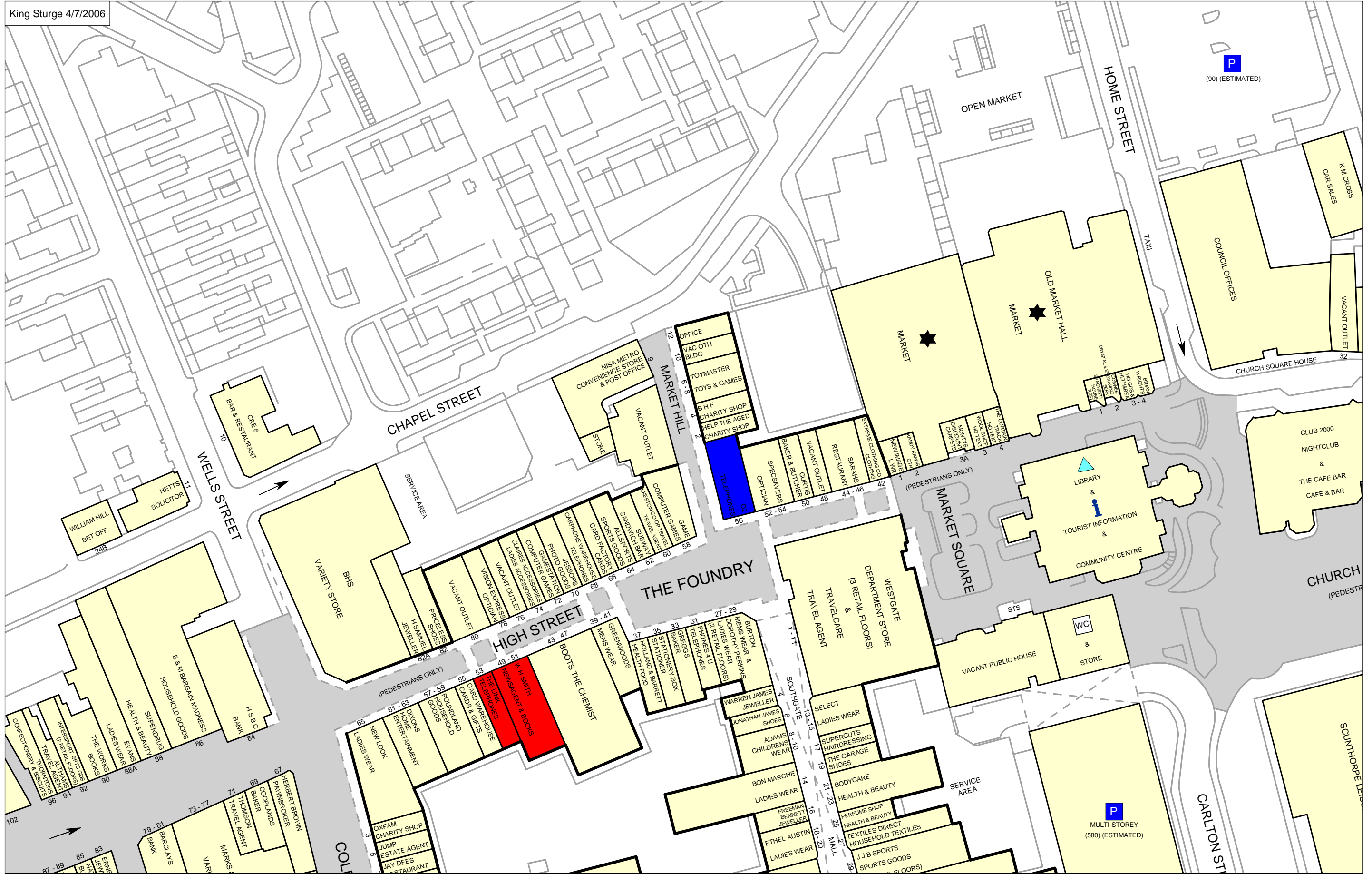

goad For more information on our products and services:
www.goadplans.co.uk
 0845 6016011
goad.sales@uk.experian.com

COPYRIGHT AND CONFIDENTIALITY NOTICE
 2005 Experian Ltd All Rights Reserved
 Goad Digital Plans are for identification only and not to be scaled as a working drawing. This product includes mapping data licensed from Ordnance Survey®. © Crown Copyright 2005. Licence number PU 100017316. No part of this plan may be entered into an electronic retrieval system without prior consent of the publisher.
 For full terms & copyright conditions visit www.goadplans.co.uk

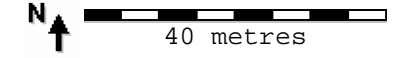

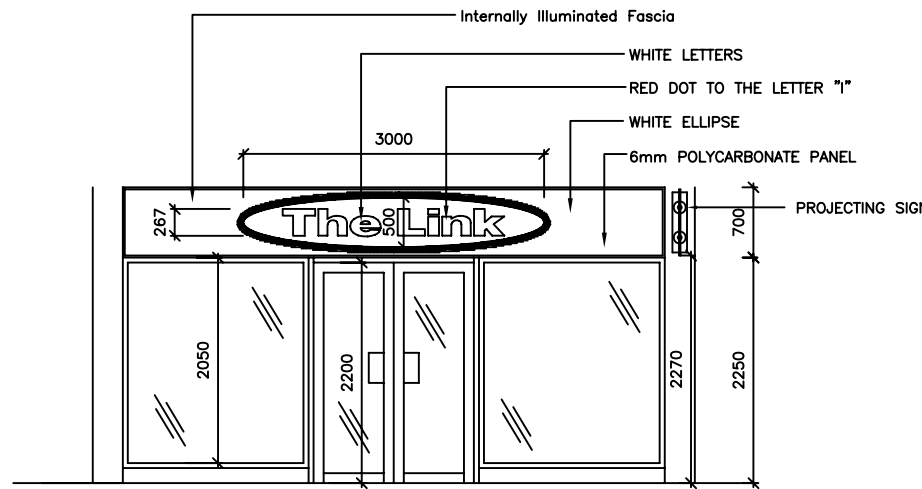

EXISTING SHOPFRONT ELEVATION

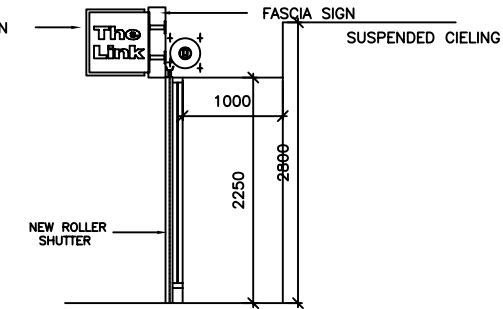

EXISTING SHOPFRONT SECTION

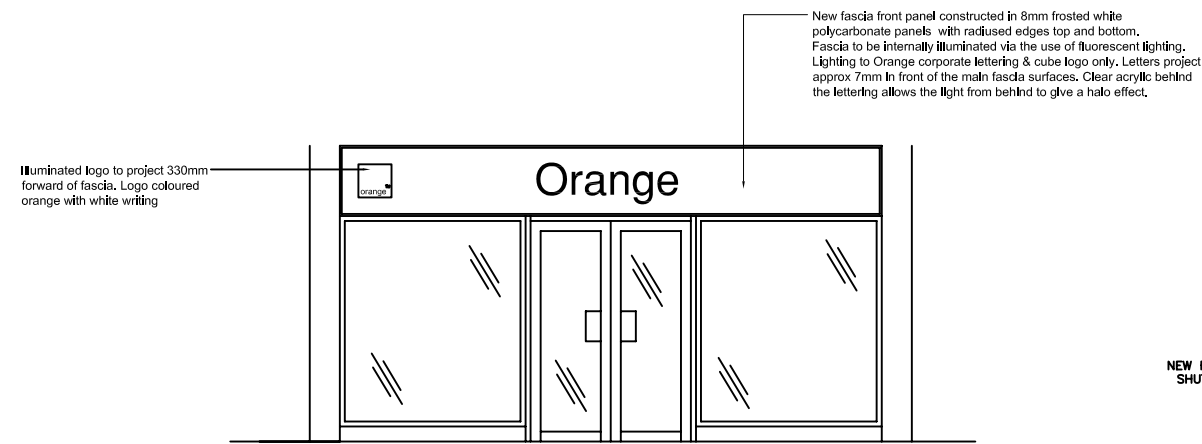

PROPOSED SHOPFRONT ELEVATION

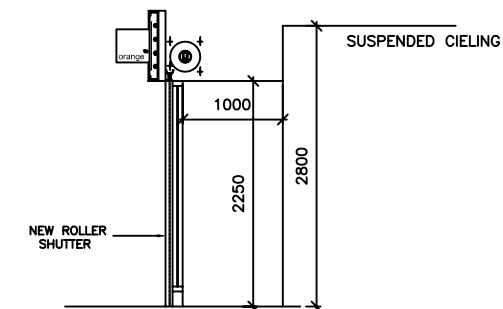

PROPOSED SHOPFRONT SECTION

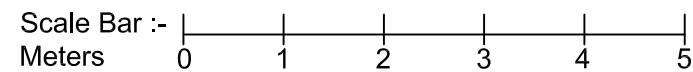

drawn by: EP / RB	date: 18 /08 /06
drawing number: S-5921-2006	
revision:	

copyright ©
**bedford
and
havenhand
shopfitting ltd**

client: Orange

contract: 53 High Street, Scunthorpe,
South Humberside, DN15 6SB

title: Existing & Proposed Layout

Carbons

adams



Orange

